

Coded locking circuit for security systems

TEA5500
TEA5500T

GENERAL DESCRIPTION

The TEA5500 is an encoder/decoder circuit, for security systems. The system has the ability to transmit a complex code between an encoding and decoding unit by infrared radiation. The device can operate as an encoder or decoder depending on the external circuitry connected to the data input. The code is made by the 10 input pins E1 to E10 by connecting them either to ground (LOW) or to the positive supply (HIGH), or leaving them floating (∞). This allows $3^{10}-2$ combinations. Two combinations are prohibited; E1 to E10 = HIGH and E1 to E9 = HIGH, E10 = LOW.

Encoding

In encoding mode the data input is connected to V_p and both outputs (S1, S2) are connected to a pnp output transistor which drives (e.g.) an infrared radiation emitting diode.

After every start the encoder completes three coding runs then stops automatically.

Decoding

In decoding mode an infrared sensitive diode (e.g.) is connected to the data input via an amplifier. If the input data is recognized, the data input of the decoder is temporarily closed (disregarding immediately following data) and one of the outputs is activated for a predetermined time after which the following start will activate the other output.

If the input data is not recognized, neither of the outputs are activated and after the third coding run is completed the data input of the decoder is temporarily closed.

Output

The output is an open-collector configuration (npn), which is active LOW. It can handle a higher supply voltage than V_p (i.e. 16 V max.).

QUICK REFERENCE DATA

parameter	conditions	symbol	min.	typ.	max.	unit
Supply voltage (pin 16)	$V_p = 4.5 \text{ V}$	V_p	3.0	4.5	6.5	V
Supply current (pin 16)		I_p	1.8	2.5	3.2	mA
Operating ambient temperature range		T_{amb}	-40	-	+80	$^{\circ}\text{C}$
Storage temperature range		T_{stg}	-50	-	+150	$^{\circ}\text{C}$
Total power dissipation		P_{tot}	-	-	500	mW
Maximum voltage at outputs (pins 3,4)		V_O	-	-	16	V

PACKAGE OUTLINES

TEA5500: 16-lead DIL; plastic (SOT38).

TEA5500T: 16-lead mini-pack; plastic (SO16L; SOT162A).

Coded locking circuit for security systems

TEA5500
TEA5500T

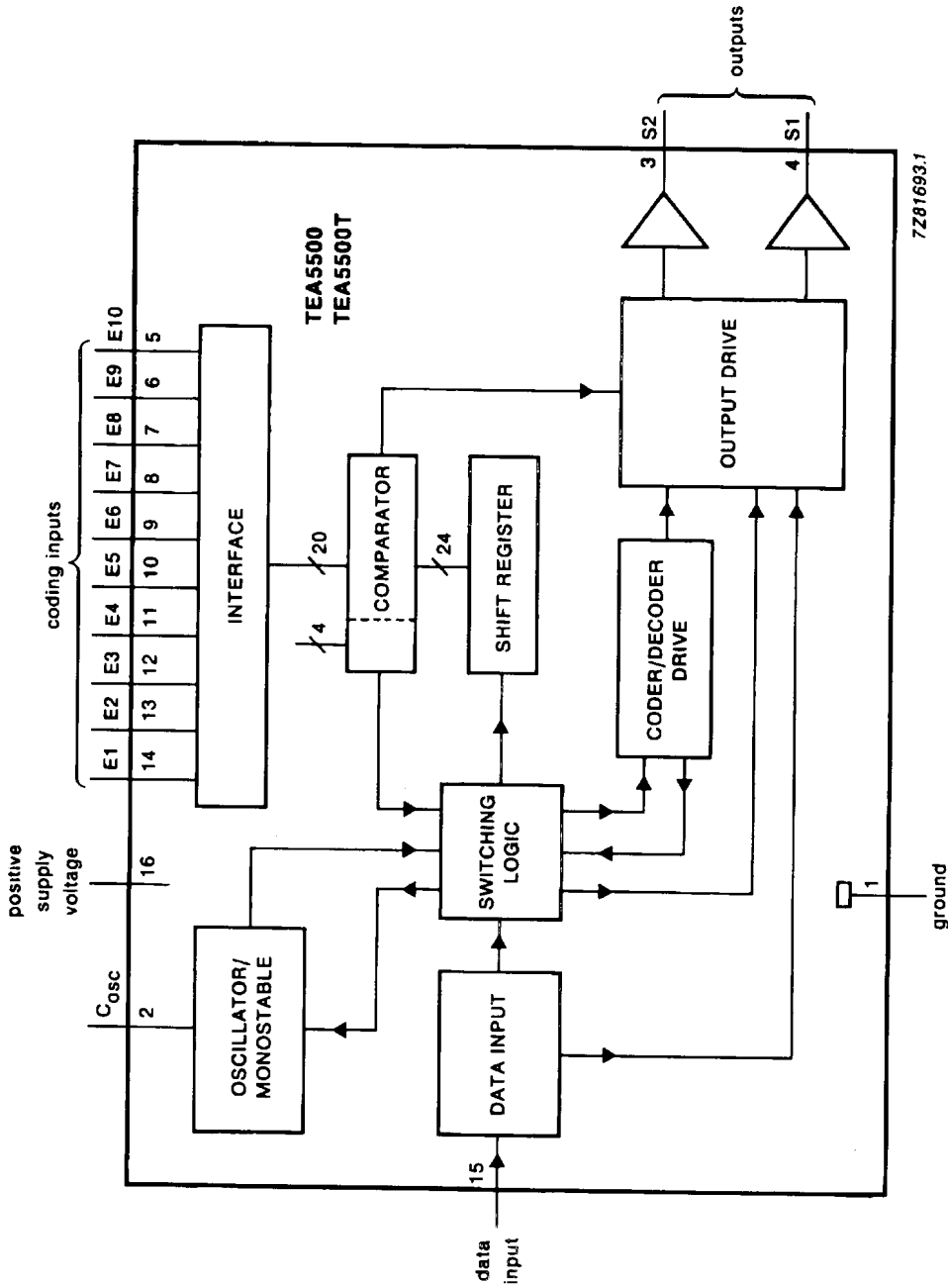

Fig. 1 Block diagram.

Coded locking circuit for security systems

TEA5500
TEA5500T

PINNING

Pin functions

pin	mnemonic	description
1	GND	ground
2	C _{osc}	oscillator capacitor
3	S2	output 2
4	S1	output 1
5	E10	coding inputs
6	E9	
7	E8	
8	E7	
9	E6	
10	E5	
11	E4	
12	E3	
13	E2	
14	E1	
15	DATA	data input
16	V _p	positive supply voltage

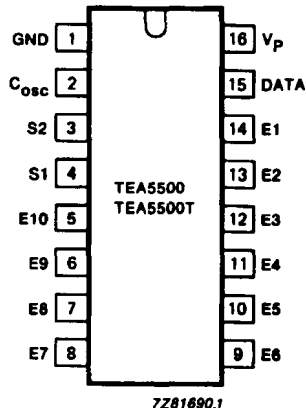

Fig. 2 Pinning diagram.

RATINGS

Limiting values in accordance with the Absolute Maximum System (IEC 134)

parameter	symbol	min.	max.	unit
Supply voltage (pin 16)	V _p	–	7	V
Supply current (pin 16)	I _p	0	50	mA
Input voltage (pins 2 and 5 to 15)	V _I	–0.3	V _p + 0.3	V
Voltage at outputs (pins 3 and 4)	V _O	–0.3	16	V
Total power dissipation	P _{tot}	–	500	mW
Storage temperature range	T _{stg}	–50	+ 150	°C
Operating ambient temperature range	T _{amb}	–40	+ 80	°C

THERMAL RESISTANCE

From junction to ambient

TEA5500: 16-lead DIL
TEA5500T: 16-lead mini-pack

R_{th j-a} = 125 K/W
R_{th j-a} = 160 K/W

Coded locking circuit for security systems

TEA5500
TEA5500T**CHARACTERISTICS** $T_{amb} = 25\text{ }^{\circ}\text{C}$; voltages with respect to pin 1; unless otherwise specified.

parameter	conditions	symbol	min.	typ.	max.	unit
Supply						
Supply voltage (pin 16)		V_P	3	4.5	6.5	V
Supply current	$V_P = 4.5\text{ V}$	I_P	1.8	2.5	3.2	mA
Zener diode voltage across supply	note 1	V_Z	—	—	8	V
Inputs E1 to E10						
Input voltage HIGH		V_{IH}	$V_P - 0.3$	—	—	V
Input voltage LOW		V_{IL}	—	—	0.3	V
Input voltage floating		V_{IFL}	1	—	$V_P - 1$	V
Input current HIGH		I_{IH}	2	7	12	μA
Input current LOW		I_{IL}	-4	-9	-15	μA
Input current floating		I_{IFL}	—	—	2	μA
Data input						
Input voltage						
for encoding mode		V_{de}	$V_P - 0.6$	V_P	$V_P + 0.3$	V
for decoding mode HIGH		V_{ddH}	0.8	—	$0.5 V_P$	V
for decoding mode LOW		V_{ddL}	—	—	0.5	V
Input current						
in encoding mode	$V_{15} = V_P = 4.5\text{ V}$	I_{de}	8	16	25	μA
in decoding mode HIGH	$V_{15} = 2\text{ V};$ $V_P = 4.5\text{ V}$	I_{ddH}	—	—	2	μA
in decoding mode LOW	$V_{15} = 0.3\text{ V};$ $V_P = 4.5\text{ V}$	I_{ddL}	-8	-16	-25	μA
Minimum pulse width of DATA input signal		r_{dp}	2	—	—	μs
Output (pins 3 and 4)						
Output sink current	output active; $V_P = 4.5\text{ V}$	I_O (sink)	25	—	—	mA
Voltage at output		V_O	—	—	16	V

Note to the supply characteristics

1. Maximum Zener diode current 10 mA.

Coded locking circuit for security systems

TEA5500
TEA5500T

parameter	conditions	symbol	min.	typ.	max.	unit
Oscillator characteristics						
Switching voltage thresholds						
high level	$V_p = 4.5 \text{ V}$	V_{th}	3.10	3.32	3.50	V
low level		V_{tl}	0.65	0.71	0.90	V
Input current						
after switching high level		I_{th}	27	36	45	μA
after switching low level		I_{tl}	-6.7	-9	-11.3	μA
Ratio I_{th}/I_{tl}		ΔI_{osc}	3	4	5	
Duration of oscillator pulse						
in coding mode	note 1	τ_c	20	$0.4 \cdot C_{osc}(\text{pF})$	—	μs
in decoding mode		τ_d	$3 \cdot \tau_c$	$0.4 \cdot C_{osc}(\text{pF})$	$5 \cdot \tau_c$	μs
Oscillator capacitor						
in coding mode	notes 1 and 2	C_{osc}	56	—	—	pF
Duration of						
output active status		τ_o	—	$384 \cdot \tau_d$	—	
data input disabled status		τ_x	—	$576 \cdot \tau_d$	—	
Influence of temperature on						
duration of oscillator pulse		$\frac{\Delta \tau_c / \tau_c}{\Delta T}$	—	0.002	—	K^{-1}
Influence of supply voltage on						
duration of oscillator pulse		$\frac{\Delta \tau_c / \tau_c}{\Delta V_p}$	—	—	0.16	V^{-1}

Notes to the oscillator characteristics

1. Minimum value encoder — capacitor must provide minimum pulse width of DATA pulse $\tau_{dp} (= 0.2 \tau_c)$.
2. Ratio encoder/decoder capacitor 1 : 4.

Coded locking circuit for security systems

TEA5500
TEA5500T

Code

The code consists of 24 bits. Each bit is represented by presence or absence of a data pulse following a clock pulse. The first 10 pairs of bits are determined by the connections of the input pins (E1 to E10). The last 4 bits form the recognition code. For the corresponding code in decoding mode the order of the input pins is reversed and connections "low" (L) and "floating" (∞) are interchanged.

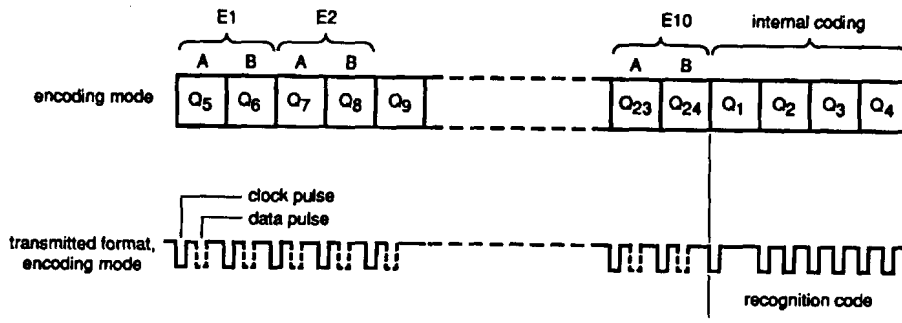

MLA195 - 1

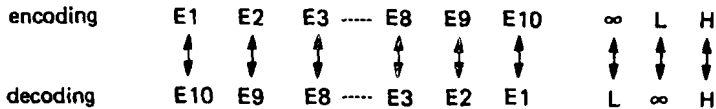

E	A	B	Q _A	Q _B
L	1	0	0	1
∞	0	1	1	0
H	1	1	0	0

example

encoding E1 = L E2 = H E3 = ∞ E4 = H E9 = L E10 = ∞

decoding E10 = ∞ E9 = H E8 = L E7 = H E2 = ∞ E1 = L

Fig. 3 Coding diagram.

Coded locking circuit for security systems

TEA5500
TEA5500T

TIMING

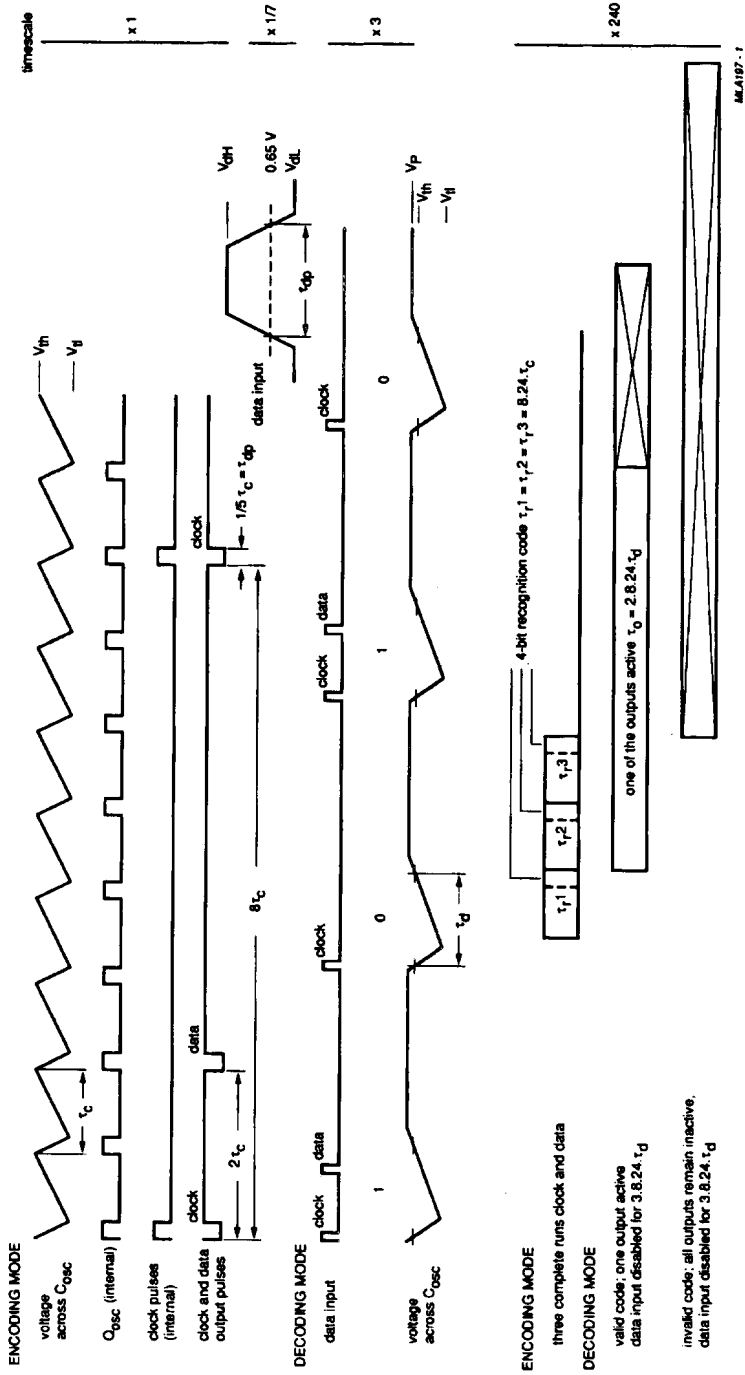
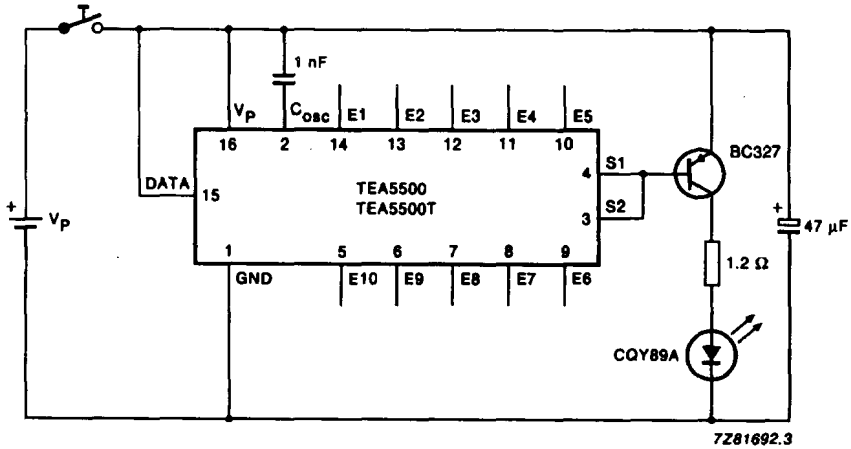

Fig. 4 Timing diagram of TEA5500.

Coded locking circuit for security systems

TEA5500
TEA5500T

APPLICATION INFORMATION



E1 – E10: code (H,L, ∞).

Fig. 5 Application diagram; coding mode.

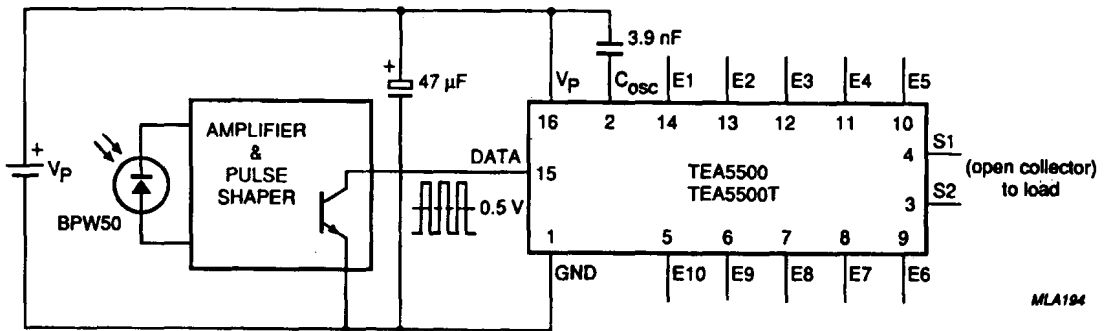

E10 – E1: code (H, ∞, L).

Fig. 6 Application diagram; decoding mode.

Coded locking circuit for security systems

TEA5500
TEA5500T

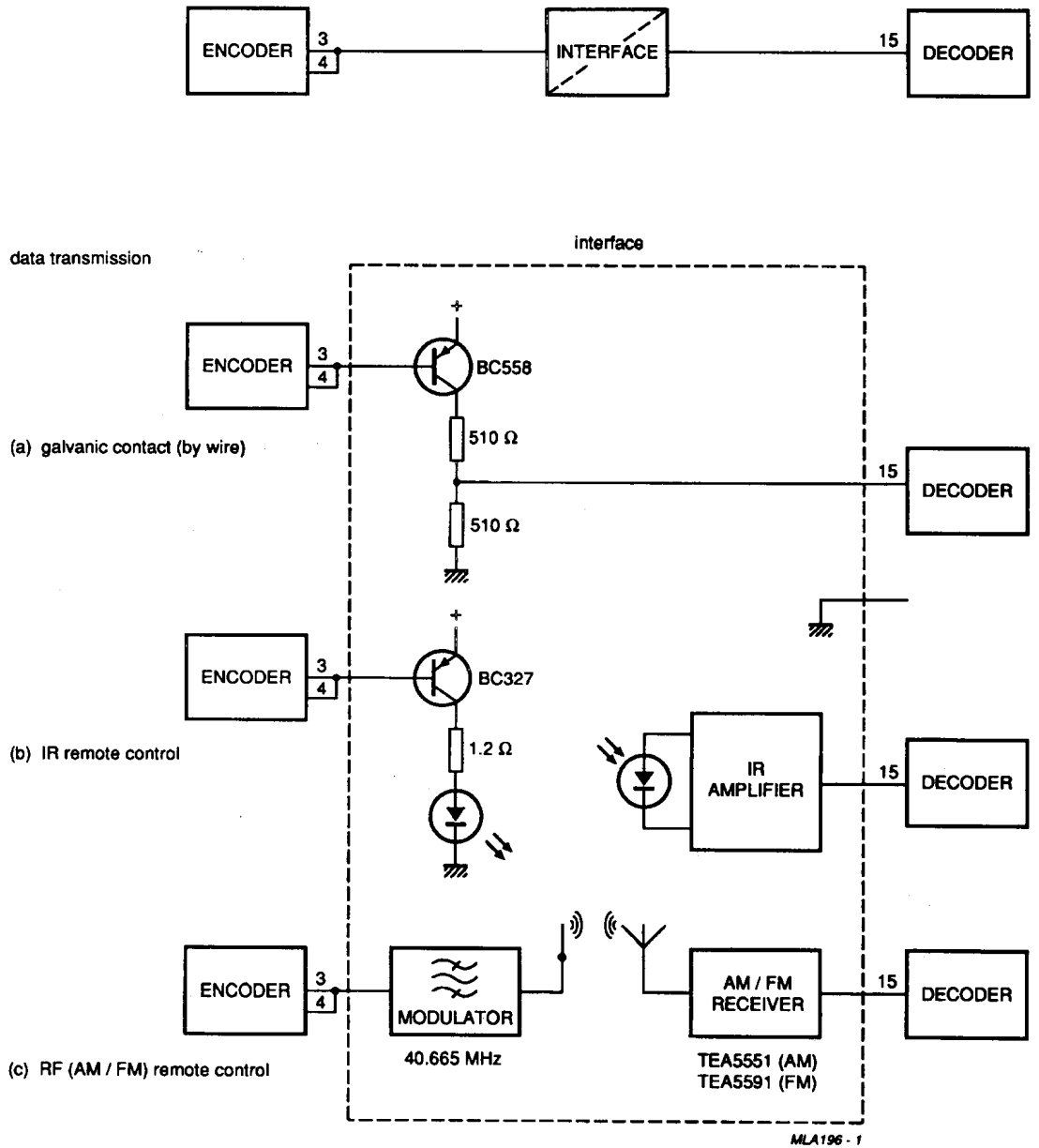

Fig. 7 Application diagram; types of data transmission possible by using different interfaces.